



## **BOREHOLE GEOLOGY AND ALTERATION MINERALOGY IN THE UPPER HALF OF WELL HE-3, HELLISHEIDI, SW-ICELAND**

**Endalkachew Getaneh,**  
Geological Survey of Ethiopia,  
Hydrogeology, Engineering Geology and Geothermal Studies Department,  
P.O. Box. 4006, Addis Ababa,  
ETHIOPIA  
*geology@telecom.net.et*

### **ABSTRACT**

The 1887 m deep exploration well HE-3 was drilled at Hellisheidi high- temperature field in the Hengill geothermal area in SW-Iceland during June-August 2001. The well is directionally drilled below 330 m and this project, which deals with the upper 812 m of the well, shows a stratigraphical section with volcanic rocks of basaltic composition that includes lava flows and subglacial formations of hyaloclastites, intruded by a couple of narrow basaltic intrusions. The hyaloclastite formations make up about 90% of the whole section and are composed of pillow lava, breccia and tuff. Four alteration zones are identified: smectite - zeolite zone (20-250 m), mixed layer clay zone (250-370 m), chlorite zone (370-792 m), and chlorite - epidote zone (>790 m), indicating temperatures of <200°C, 200-230°C, 230-250°C, and >250°C, respectively. The time related mineral depositional sequence shows that the geothermal system has evolved from a low-temperature through intermediate- to a high-temperature system. Calcite deposition succeeding the high-temperature assemblage may imply later cooling. The shape of the alteration temperature curve suggests that the well is located near an upflow zone in the geothermal system. Aquifers are generally small and confined to the upper 180 to 500 m depth interval. They are related to lithological boundaries and intrusion contacts. All these aquifers are nonproducing and are excluded by casing and subsequent cementing of the well. Based on the geological findings, hydrothermal alteration analysis and field relationships of geological units and structures, a possible conceptual geothermal model is proposed for the upper part of the geothermal system into which the well was drilled.

## **1. INTRODUCTION**

### **1.1 General information**

This report is a result of the main project carried out during the six-months fellowship at the UNU Geothermal Training Programme, awarded to the author for participation in the specialized course of Borehole Geology at Orkustofnun, Iceland, in the year 2001. The report deals with the borehole geology

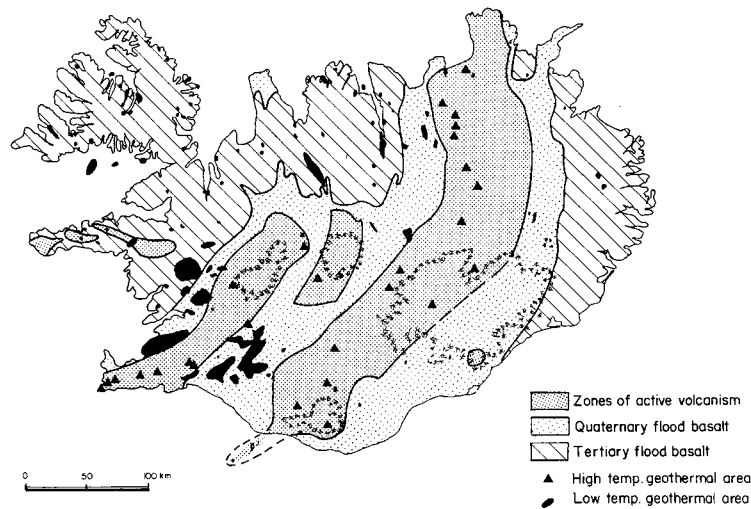

FIGURE 1: A simplified geological map of Iceland

(1995a and b). Other surface explorations have also been carried out in the area including a geophysical survey, seismic monitoring, mapping of surface thermal activity and alteration, hydrology and geothermal gas analysis to estimate subsurface temperature (Steingrímsson et al., 2001).

Well HE-3 is one of two deep geothermal exploration wells that Reykjavík Energy Co. drilled in the Hellisheidi geothermal field during the summer of 2001. The Reykjavík Energy Co., which supplies the city of Reykjavík with electricity, hot water for house-heating and cold tap water, owns a large sector of the Hengill geothermal area. It has financed and organized many of the geothermal exploration activities in the area. Two deep exploratory wells, one at Kolvidarhóll (KhG-1) to the west and the other at Ölkelduháls (ÖJ-1) to the northeast, were drilled in 1985 and 1994-1995, respectively. However, most of the drilling activities have been concentrated in the Nesjavellir high-temperature geothermal field located in the northern part of Hengill. A series of 22 deep geothermal wells have been drilled there. Most of them are production wells connected to a geothermal power plant and heating system, which generates electricity and hot water for central heating in Reykjavík and surrounding communities, run by the Reykjavík Energy Co.

Well HE-3 is a directionally drilled to a total measured depth of 1887 m. The purpose of this study project is to evaluate the geological structures controlling fluid movement and temperature conditions of the geothermal reservoir in the first 812 m of the well, based on petrological and alteration mineralogical analysis of drill cuttings, together with data from the drilling and geophysical logging. This part of the well was cased off by surface, anchor and production casings, before the production section of the well was completed.

## 1.2 Materials and methods

Drill cuttings from well HE-3 were the main material used for this study. A total of 400 cutting samples were collected at two metre intervals during drilling. Out of these, 45 samples were taken for thin-section analysis and 26 samples were carefully selected and prepared for X-ray diffraction analysis.

A binocular microscope was used to identify rock type, structure and alteration minerals in the cuttings. The detailed petrographic studies on the thin sections were undertaken by using a petrographic microscope. In addition, a Philips X-ray diffraction (XRD) machine was used for clay analysis and identification of some alteration minerals like zeolites, which would otherwise be impossible to identify. Moreover, geophysical lithological logs and other drilling data were used to assist in constructing the geological outlines of the geothermal system drilled.

and alteration mineralogy in the first 812 m of well HE-3. The well is located in Hellisheidi, within the Hengill high-temperature geothermal area of SW-Iceland. The geothermal area associated with the Hengill central volcano covers an area of about 40 km<sup>2</sup> (Björnsson et al., 1986). Hellisheidi geothermal field is the southern part of the Hengill geothermal area located south of Stóra Skardsmýrarfjall mountain (Figure 1).

The geology of the area has been described by many workers including Saemundsson (1979), Foulger (1988), and Saemundson,

## 2. SURFACE GEOLOGY

The high-temperature geothermal areas in Iceland are all found within the Mid-Atlantic accretionary plate boundary that crosses the island from southwest to northeast for over 700 km. The Hellisheidi geothermal field lies in the southern part of the Hengill geothermal area, which in turn is found within the western volcanic zone in S-Iceland (Figure 1).

Volcanic rocks of basaltic composition characterize the surface geology of the area at large. They fall into tholeiitic or olivine tholeiitic composition and are either aphyric or porphyritic. Several periods of glaciations have occurred in Iceland during Quaternary times. During these times successions of volcanic rocks have been formed either in subglacial or subaerial (interglacial) conditions. During glacial periods magma erupts under the glacier and forms a lake by melting the ice cover. This provides suitable conditions for the formation of pillow lava. If melting of the ice sheet continues, the growing pile of pillow lava becomes unstable and slumps to form breccias, which are predominantly composed of pillow fragments. These pile up to reach shallow water level where explosive phreatic eruptions occur which form vast quantities of glassy tuffs. This overlies the pillow basalt and if the eruption emerges above the water surface, lava flows start to form a flat topped mountain known as a “Table mountain” like the Hengill mountain (Saemundson, 1979). The hyaloclastite ridges in the northeast, north and west of the field are composed of pillow lava, breccia and tuffs formed during the last glacial period. Flat lying basaltic lavas covering the central parts of Hellisheidi, including the lava on which the well is located, are Postglacial and erupted 5000 and 2000 years ago (Figure 2).

The major tectonic features include a NE-SW trending swarm of normal faults. They are covered by the Postglacial lavas in the central parts of the field, but emerge out of the lava field south of the area. A few major faults and eruptive fissures cut through the lava field and the hyaloclastite ridge in its east and west sides (Saemundson, 1995a). These major faults are thrown towards the eruptive fissures, which may indicate that the latter are located within a graben structure (Figure 2).

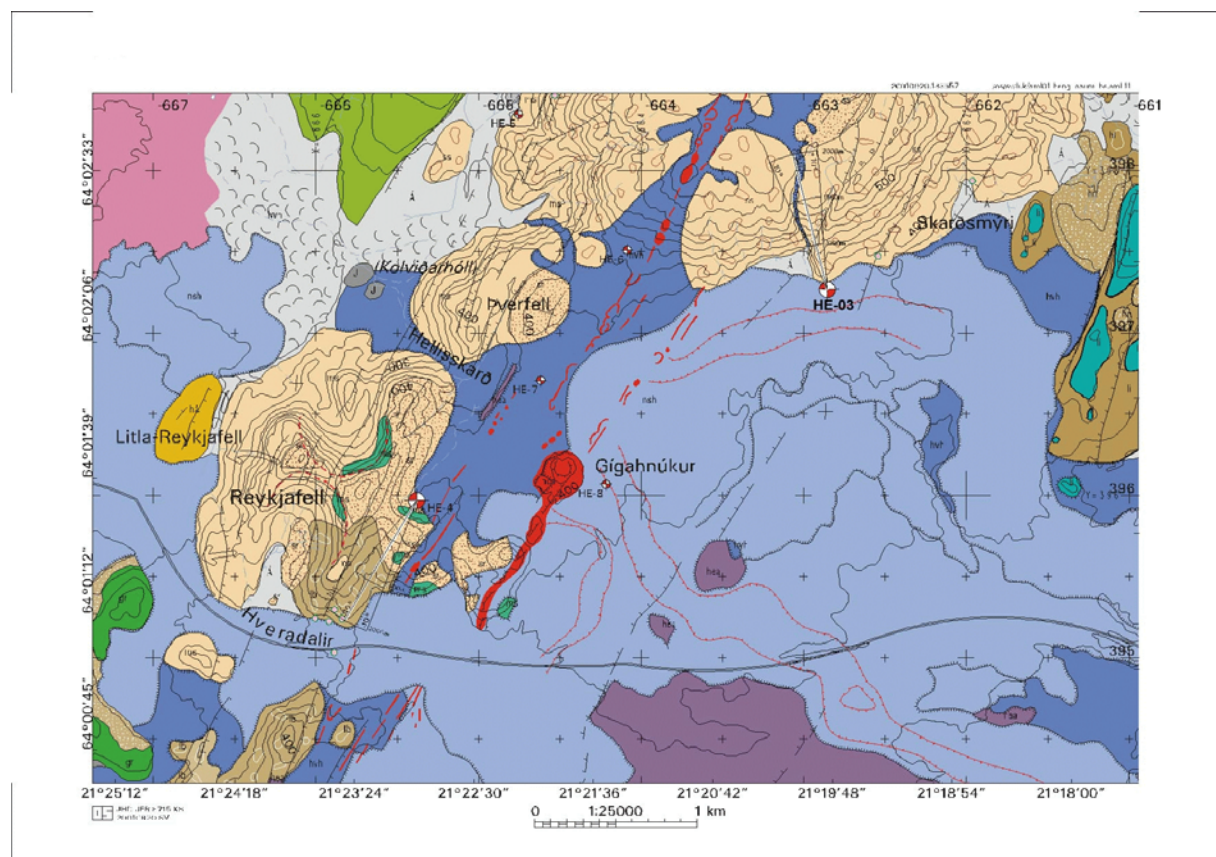

FIGURE 2: Geological map of Hellisheidi area

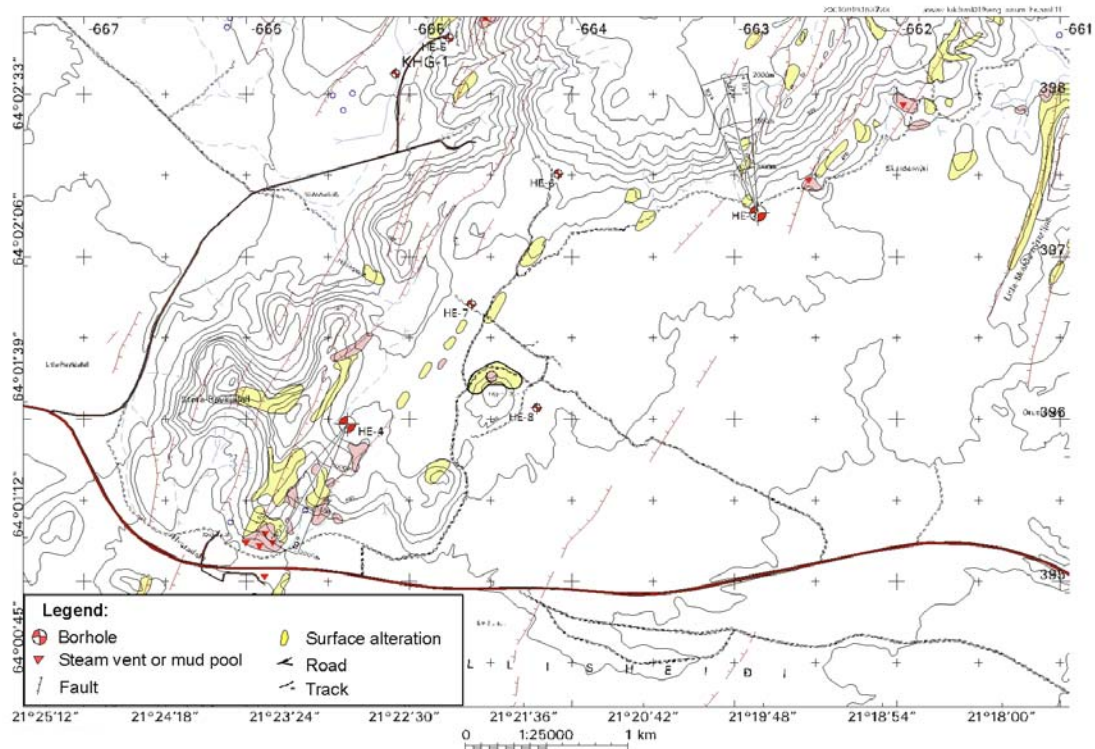

FIGURE 3: Map showing surface alteration and location of well HE-3

The surface expression of geothermal activity in the area shows both fossil and active thermal manifestations. These include steam vents, steaming grounds, hot springs, solfataras, warm soils, and altered grounds (Saemundsson, 1995b). There are no active geothermal manifestations found associated with the Postglacial volcanic fissures. However, steam vents and warm soils are located along the eastern and western faults (Figure 3).

Extensive resistivity surveys have been done in the area including Schlumberger and TEM resistivity measurements (Björnsson et al., 1986, Steingrímsson et al., 2001). Figure 4 shows the resistivity at 200 m a.s.l. or at about 100-500 m below surface. The main feature is a high-resistivity zone (50-500 ohm m) which was observed beneath a 100-200 m thick low-resistivity layer that reaches down to 200-300 m a.s.l. A correlation made between resistivity, rock temperature and alteration at Nesjavellir (northwest of Hellisheidi) shows that high-resistivity values can be attributed to fresh rocks, while low-resistivity values (1-5 ohmm) were measured in the smectite-zeolite belt at temperatures of 50-200°C. More important is the high resistivity recorded below the low resistivity, where chlorite and epidote became the dominant minerals at temperatures above 230°C (Steingrímsson et al., 2001, Árnason et al., 2000).

Generally, the Hellisheidi geothermal field has geological and structural features on the surface which indicate a site of regional thermal anomaly where the search for geothermal resources could be very successful.



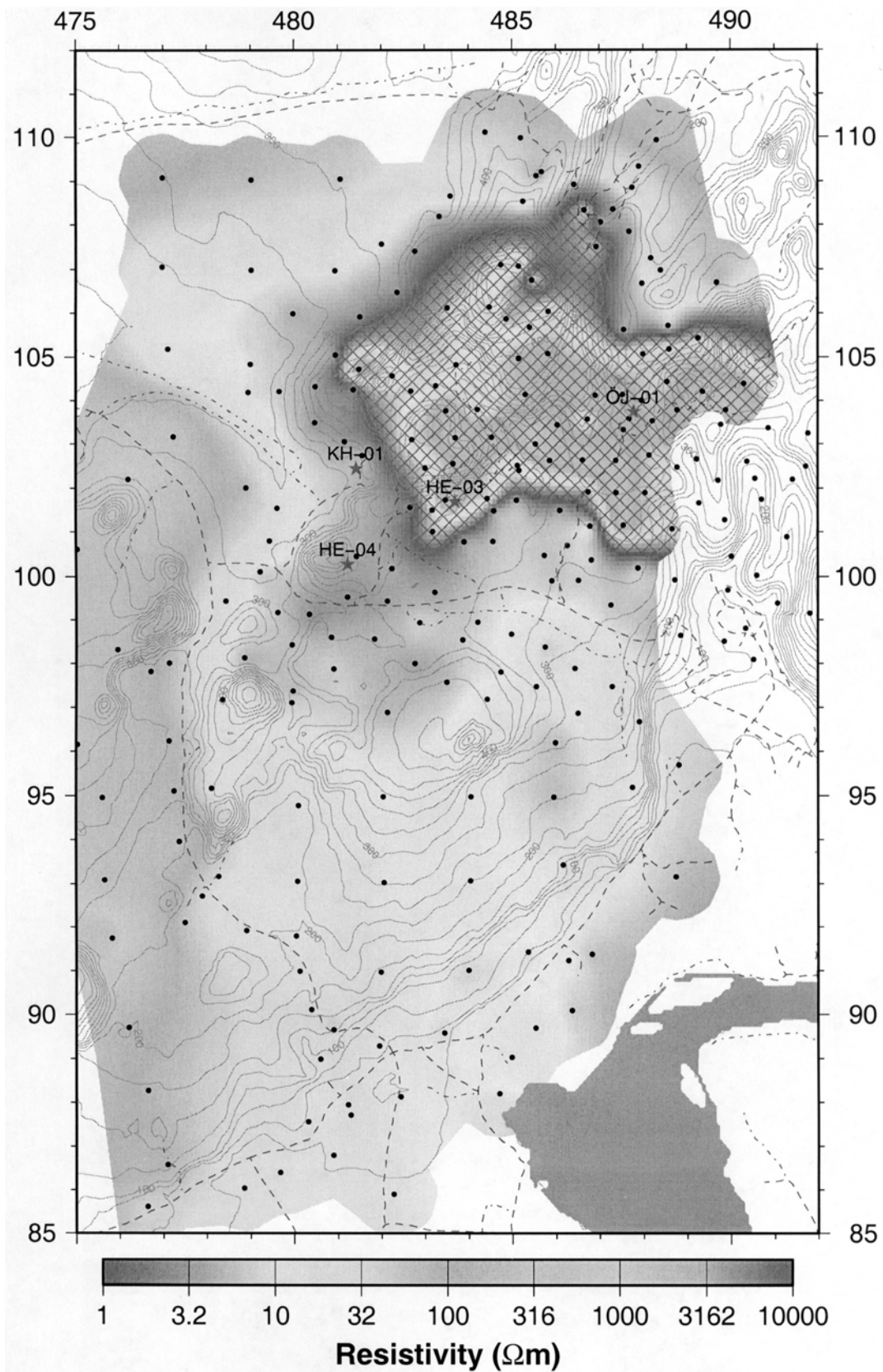

FIGURE 4: Resistivity map of Hellsheidi area at 200 m below sea level, the cross-shaded area denotes high resistivity below low resistivity typically found in the centres of active high-temperature areas where temperatures exceed 230°C; also shown are locations of exploratory wells in the southern Hengill area

### 3. BOREHOLE GEOLOGY

Exploration drilling and subsequent geological, geophysical, geochemical and other evaluations of a geothermal well comprise one of the exploration steps to be taken before any production drilling is conducted in a geothermal field. The vertical and horizontal extent of the geothermal reservoir, its thermal and hydrological characteristics, and the structures controlling the flow of geothermal fluids can be confirmed by drilling a well into the geothermal system. Based on the information gained from different surface and subsurface explorations, one or more exploration boreholes is drilled depending on the geological complexity of the area and other factors, before drilling for production wells is conducted. Well HE-3 is one of the two exploration boreholes drilled in the Hellisheidi geothermal field for these purposes. The siting of the well and the recommended direction of drilling were made based on the detailed geological, geophysical and geochemical surveys carried out in the area (Steingrímsson et al., 2001). Although well HE-3 is the first deep exploration well in this field, it is designed as a production well, for the probability of dissecting a good caliber high-temperature system was believed to be high. Following is a description of the drilling and the stratigraphy of the formation being drilled in the uppermost 812 m of the well.

#### 3.1 Drilling

Well HE-3 is a directionally drilled well in Hellisheidi geothermal field within the Hengill high-temperature geothermal area. It is located at the southeastern margin of Stóra Skardsmýrarfjall (SK) mountain, at coordinates (Lambert): X = 385995.17 and Y = 395056.06 and at about 384 m elevation a.s.l. The aim of the directional drilling was to dissect a northeast trending major fault which is found about 200 m west of the wellhead at some depth under Skardsmýrarfjall (Figure 2). It is one of two large faults found at its foot. Well HE-3 is sited between the two faults. Both trend N30°E and are postulated to dip about 7° from vertical to the west. Moreover, since both are major tensional faults, they are assumed to be near-vertical at the surface and become gradually inclined at several hundred meters depth (Steingrímsson et al., 2001). Figure 5 shows the different possibilities for the well to intersect the fault at different depths below the surface, at 345° ± 10° direction.

The drilling was carried out by the Icelandic drilling contractor, Jarðboranir hf, in July 2001, with special supervision from the international company, Halliburton,

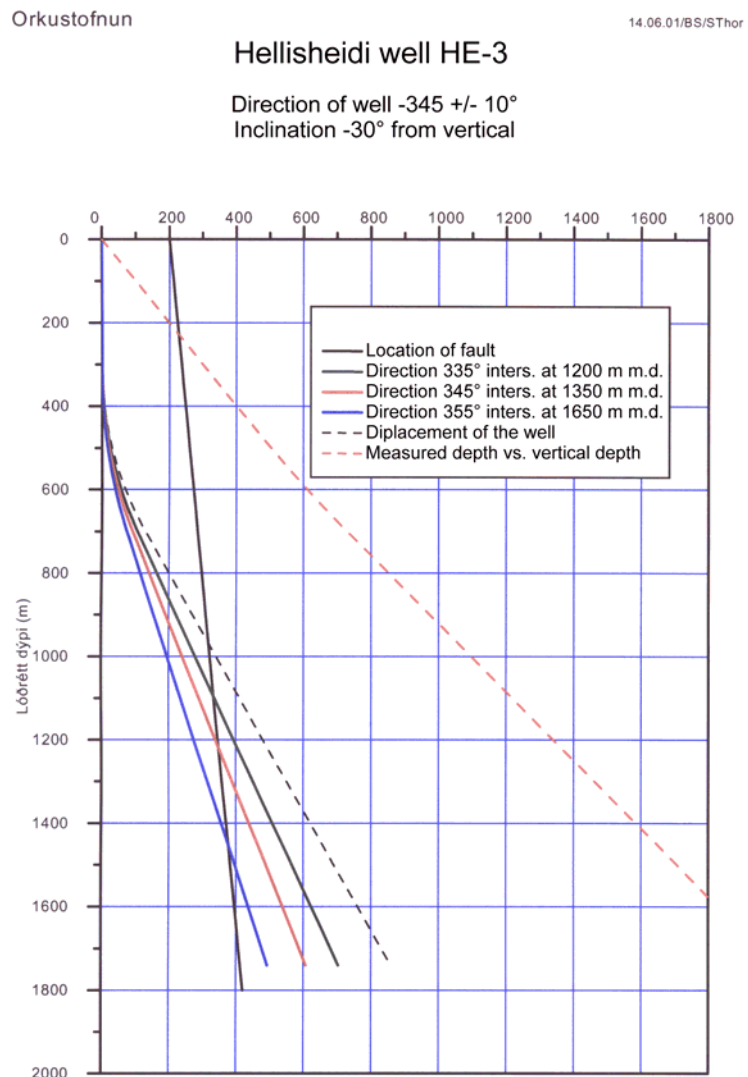

FIGURE 5: The different angles for well HE-3 to intersect the targeted fault and different depths for the 345° ± 10° direction (after Steingrímsson et al., 2001)

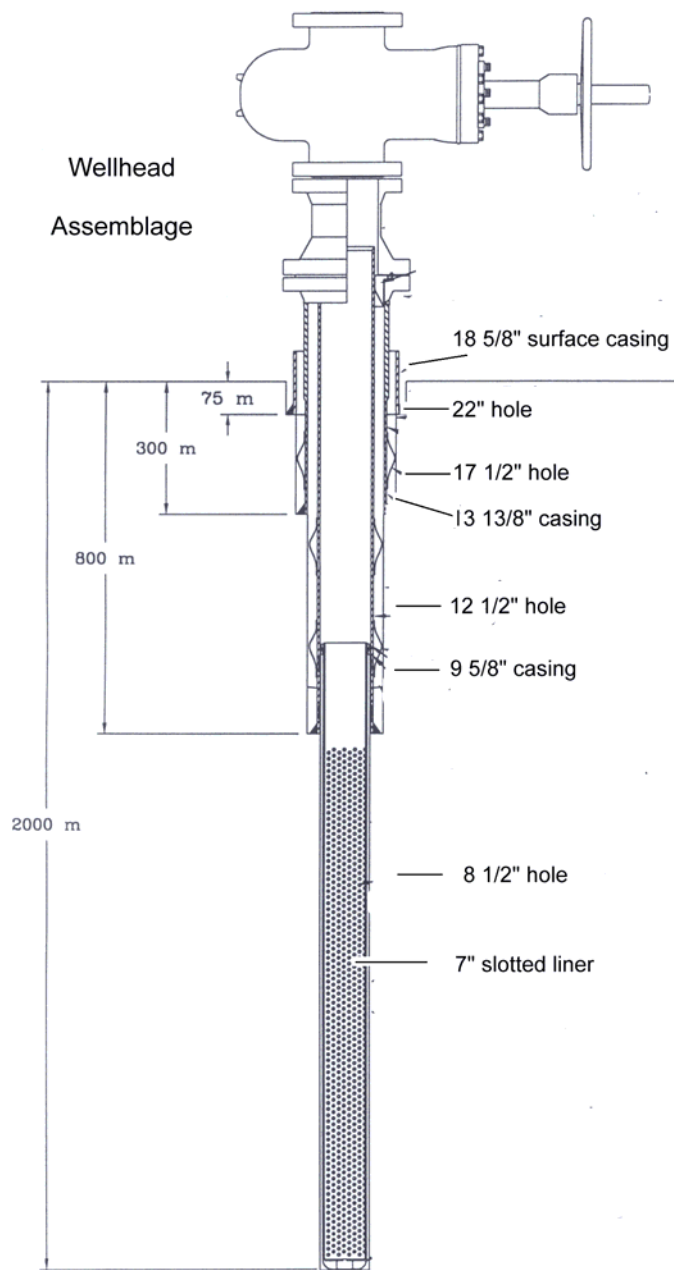

FIGURE 6: A diagram showing the design of well HE-3

temperature, natural gamma, neutron-neutron, and caliper logs, were made before the well was cased and cemented. Circulation-losses were also monitored at regular intervals. In addition to these, a continuous data log of the temperature of the drilling fluid, pressure on the mud-pumps and rate of penetration were acquired through a computer connection with different parts of the rig.

### 3.2 Stratigraphy

A simplified vertical section of the geological formations to 812 m depth is shown in Figure 8 along with the

for the directional drilling. The drilling was performed in four stages (Figure 6). The first 95 m for the surface casing were pre-drilled by a suitable rig for that kind of a project. A 22" bit and 18<sup>5</sup>/<sub>8</sub>" casing were used for the drilling and casing, respectively. Later, after this casing was cemented, a bigger rig took over the drilling, down to the bottom at 1887 m. The second stage of the well was then drilled down to 330 m depth with a 17<sup>1</sup>/<sub>2</sub>" bit before a 13<sup>3</sup>/<sub>8</sub>" casing was placed and cemented. The third stage was drilled down to 812 m for the production casing with a 12<sup>1</sup>/<sub>4</sub>" bit. A 9<sup>5</sup>/<sub>8</sub>" production casing was then placed from bottom to top. The last stage was drilling of the production part down to the bottom, at 1887 m. The bit used was 8<sup>1</sup>/<sub>2</sub>" and the well was lined with a 7" perforated casing.

The kick-off point for the directional drilling was at about 330 m. From there, with a special bottom hole assembly, the inclination started to build up gradually, at a rate of 2.5°/30 m until 35° was reached at about 800 m (Figure 7) at a direction of 345°. Measurements while drilling (MWD) readings, aided by a few gyro surveys, were used to control the direction and inclination of the well.

Cuttings were collected every 2 m for the entire depth of the well. After each stage of drilling, geophysical logs, such as

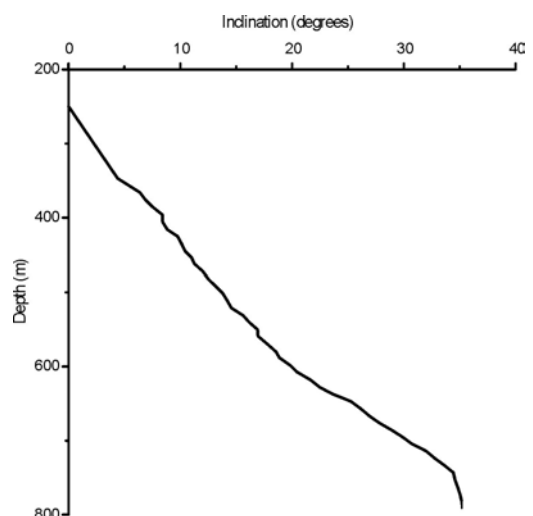
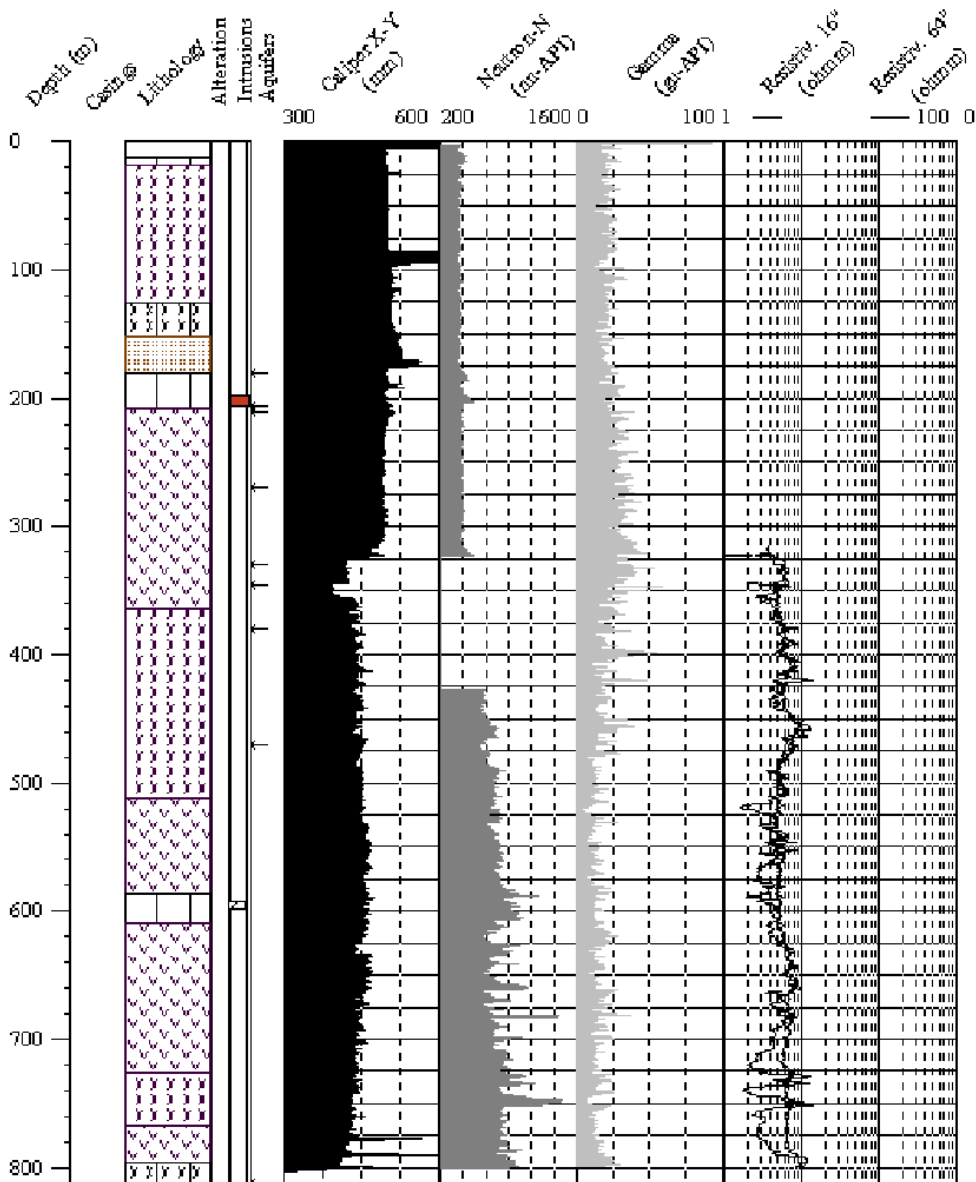

FIGURE 7: Inclination vs. depth graph of the directional drilling of well HE-3 to 812 m



**Legend**

- |                            |                         |                    |
|----------------------------|-------------------------|--------------------|
| <b>Rock types</b>          | <b>Alteration zones</b> | <b>Intrusions</b>  |
| Basaltic tuff              | Fresh zone              | Intrusion          |
| Basaltic breccia           | Smectite-zeolite zone   | Possible intrusion |
| Poorly crystallized basalt | Mixed layer clay zone   | <b>Aquifers</b>    |
| Fine-medium grained basalt | Chlorite zone           | Small              |
| Tuffaceous sediments       | Chlorite-epidote zone   | Medium             |
| No cuttings                |                         | Large              |

FIGURE 8: A simplified stratigraphical section and lithological and geophysical logs in the upper 812 m of well HE-3 with location of aquifers



various geophysical logs. The rocks are generally either of extrusive hyaloclastites and lava flows or intrusions, all of basaltic composition. Hyaloclastites make up about 90% of the whole drilled section. They are composed of tuff, breccia and pillow lavas. Fine- to medium-grained basalts form thin layers in-between the hyaloclastites at different depths. A couple of narrow basaltic intrusions were encountered at 198-208 m and another possible intrusion at 592-600 m depths in the well.

Owing to the varying porphyritic nature of the rocks, the hyaloclastites are grouped into five separate eruptive units; the basalt lavas from the last Postglacial period are treated separately. These are discussed below:

**Basalt (0-18 m).** This basalt lava unit seems to belong to the two Postglacial fissure lavas erupted 5000 and 2000 years ago. The unit is relatively fine-grained composed of plagioclase, augite, magnetite/ilmenite and olivine. Except for very small oxidation tints on vesicular walls at about 14 m, it is unaltered fresh basalt. Its texture is suggestive of an olivine tholeiite composition.

**Hyaloclastite I (18-152 m).** It is composed of a basaltic breccia overlying pillow lava. This unit is generally fresh to slightly altered, with plagioclase and minor pyroxene phenocrysts. It is highly vesicular with many open fractures and vesicles lined with thin layers of clay, opal, chalcedony, zeolites and calcite. The degree of alteration slightly increases with depth until it reaches the base of the pillow lava.

**Hyaloclastite II (152-364 m).** This unit is uniformly composed of an aphyric basaltic tuff with thin layers of tuffaceous sediment and a microcrystalline basalt layer at the top. It is almost devoid of any plagioclase and/or any other phenocrysts. The tuffaceous sediment shows thin sedimentary bedding structures emphasizing its water-lain characteristics. It is highly vesicular and fractured with many of the vesicles and veins filled with secondary minerals like zeolites, quartz, clay (smectite and mixed layer clays), pyrite and calcite. Pyrite is very abundant and forms well developed euhedral crystals. There is a sharp change in the degree of alteration between the upper hyaloclastite formation and this unit. The former is only slightly altered with many open veins and vesicles lined with thin layers of clay, zeolites and calcite, while this one is highly altered with many of the vesicular spaces filled with secondary minerals. The glassy groundmass has also been highly altered to calcite and, in places, to sphene (titanite).

**Hyaloclastite III (364-512 m).** This formation is composed of basaltic breccia except for very thin layers of tuffs and pillow lava in places. It is differentiated from the tuffaceous formation above and below by its plagioclase porphyritic texture. It is moderately to highly altered with many of the vesicles and veins filled with secondary mineral deposits like pyrite, calcite, quartz and wairakite.

**Hyaloclastite IV (512-726 m).** This unit is 214 m thick and consists of basaltic tuff with alternating layers of pillows and basaltic breccias. There is also a fine-grained thin basalt layer between 586 and 610 m depth. All these basalt layers correlate very well with the higher values on the neutron-neutron log (Figure 8). This unit is generally aphyric in texture, probably of olivine tholeiitic composition.

**Hyaloclastite V (>726 m).** This formation is the most highly porphyritic unit of all the rocks seen so far in the well. Thin sections from the sample taken at 728 m show large plagioclase phenocrysts, which are highly affected by alteration where fracturing and alteration of the plagioclase to calcite, albite, wairakite, sphene and probable epidote is very evident. The unit is generally composed of a highly altered sequence of pillow lavas, breccias, and tuffs. There is a very good correlation between the neutron-neutron and resistivity values in the upper basaltic breccia, which indicates better crystallization. The base of this hyaloclastite formation lies below 812 m depth.

### 3.3 Intrusions

Intrusive rocks form narrow sections at two different depth intervals. They are correlated with higher neutron-neutron values in the geophysical logs (Figure 8). The first intrusion was encountered at the 200-208 m interval. It is a fine-grained basalt with sparse plagioclase phenocrysts. It is fresh and different

from the basaltic lava above and the basaltic tuff below, as it is plagioclase porphyritic.

The second probable intrusion is found at about 592-600 m depth. Unlike the underlying thin basaltic lava, this rock is composed of fine-grained relatively fresh basalt. The basalt layer below is moderately altered and is composed of fine- to medium-grained plagioclase/pyroxene porphyry. This intrusion has a uniformly fine-grained equigranular texture, which may indicate a tholeiitic composition. The degree of alteration, and the different texture and composition from the lava below indicate a possible intrusive origin.

Generally, the succession shows dominant hyaloclastite formations erupted during glacial episodes. Interglacial lava formations separating the hyaloclastites cannot be identified with certainty and therefore a relative age dating will have to be deferred until more data is available. One can assume though that Stóra Skardsmýrarfjall formation, which extends down to 152 m depth, erupted during the last glacial period (< 115,000 yrs).

#### **4. HYDROTHERMAL ALTERATION**

In hydrothermal alteration we are dealing with rock alteration and minerals precipitated in void spaces and fractures, due to hydrothermal fluids rising from deep levels to the surface. When the hot surrounding rocks heat up a deep circulating water in an active volcanic area, the rocks get altered and release ions into the solution. This hydrothermal solution, upon heating, rises as a mineral-bearing fluid. On its way up, minerals crystallize out of the solution onto the walls of open cavities, vesicular structures and veins in the overlying rock formations. Characteristic mineral assemblages are formed at different depth intervals. The type and amount of mineral deposition depends on many factors like temperature, rock type, pressure, permeability, fluid composition and duration of activity (Browne, 1978). Therefore, knowledge of the hydrothermal alteration minerals is vital in many ways to evaluate the thermal history and permeability of the geothermal system. Both changes in temperature and permeability play an important role in the success of a geothermal well (Elders, 1977).

Generally in many geothermal developments, hydrothermal alteration minerals have been used for many different purposes, such as geothermometers, for deciding the drilling depth and depths at which production casing should be placed, to estimate pH and other chemical properties of the fluid, to predict scaling and corrosion tendencies of the geothermal fluid, as a measure of permeability and possible cold water influx, and as a guide to hydrology and reconstruction of eroded overburden (Reyes, 1990).

##### **4.1 Rock alteration**

As described earlier in Section 3.2, the reservoir rocks are basaltic and mainly composed of plagioclase feldspar, pyroxenes, ore minerals (magnetite / ilmenite) and subordinate olivine. Glass is also a major constituent, especially in the basaltic tuffs. These all have different susceptibilities to alteration when they come in contact with geothermal fluid. Glass has the lowest resistance to alteration followed by olivine. The primary mineral alteration study at the Nesjavellir field shows that glass and olivine are completely altered in the upper parts of the well, while plagioclase starts altering near the lower part of the smectite-zeolite zone (Franzson, 1998). Figure 9 shows the results of this study in relation to the alteration zones.

Owing to their high glass content, the basaltic tuffs are by far the most altered units below about 150 m depth in the well. They are altered to clay, calcite and sphene in the groundmass of the tuffs. The plagioclase phenocrysts, when present in these units, show slight to extensive dissolution fractures, or are replaced by chlorite, calcite, wairakite and albite below about 388 m depth. Hardly any olivine was seen in the tuffs below a few hundred metres depth, which may be due to their total alteration in the upper part of the well. In the basaltic lavas and breccias, at depth, greenish alteration tints in the matrix indicate primary olivine alteration to clay. Pyroxene may possibly be altered to sphene and chlorite, while

magnetite may be replaced by sphene or pyrite in the lower section of the well. Nevertheless, no strong evidence was seen as to the alteration of pyroxene and other ore minerals like magnetite.

#### 4.2 Distribution of hydrothermal alteration minerals

Various alteration minerals are found in the upper 812 m of the well. Figure 10 shows the distribution of these minerals within the stratigraphical formations described earlier in Section 3. They are mostly occurring as vesicular and vein infillings in fractures, and as replacement minerals within the rock matrix. Calcite, clays and pyrite show by far the most widespread occurrences followed by zeolites, quartz and other minerals at different depths. The hydrothermal alteration minerals identified from the cutting analysis are described below.

**Calcite** is one of the most widely occurring minerals starting from the first few tens of meters to the bottom at 812 m depth. At first it appears as vesicular infilling, then as vein infillings and replacement mineral of mostly glass and plagioclase phenocrysts. Calcite is more abundant in the hyaloclastite formations than in the lava flows. It is known to occur over a wide range of temperatures, up to 290°C (Kristmannsdóttir, 1979). Zeolites, clays and quartz are usually found in association with calcite at different depths. Platy calcite is common from about 550 m down to the bottom. It is suggestive of boiling in a geothermal system. A simple HCl test can help identify calcite in cuttings. Its rhombohedral cleavage and polysynthetic twinning are also characteristic in thin sections.

**Chalcedony** occurs as cavity and vesicular linings at places associated with quartz and zeolites. It also forms an aggregate structure and gradually changes to quartz at higher temperatures.

**Quartz** is found distributed in varying abundance throughout the formations below 180 m depth. It is usually associated with wairakite and calcite. Quartz after mordenite is quite common. Euhedral prismatic crystals of quartz are abundant in veins and vesicles of the hyaloclastite formations, but is hardly seen in the groundmass as a secondary alteration mineral.

**Zeolites** are low-density, open framework structures of hydrous sodium, calcium, aluminium silicates, commonly occurring as secondary minerals in cavities of sub-silicic volcanic rocks, mostly basalts (Tschernich, 1992; Kerr, 1959). Most zeolites crystallize in a water-rich environment under a wide range of temperatures. In this well, they are abundant in veins and vesicles of the basaltic tuffs and altered breccias, especially between 120 and 400 m depth. In thin-section they are identified by their low-refractive indices and weak birefringence. They occur in fibrous or columnar structures like scolecite, thomsonite, mordenite and laumontite. XRD and further chemical analysis are needed to identify individual members of the groups. Zeolite zones are not commonly distinct in Icelandic high-temperature areas, due to the sharp increase in the thermal gradient. However, the trend in the strata shows the sequence of heulandite, mordenite, laumontite and wairakite with increasing temperature (Kristmannsdóttir, 1975).

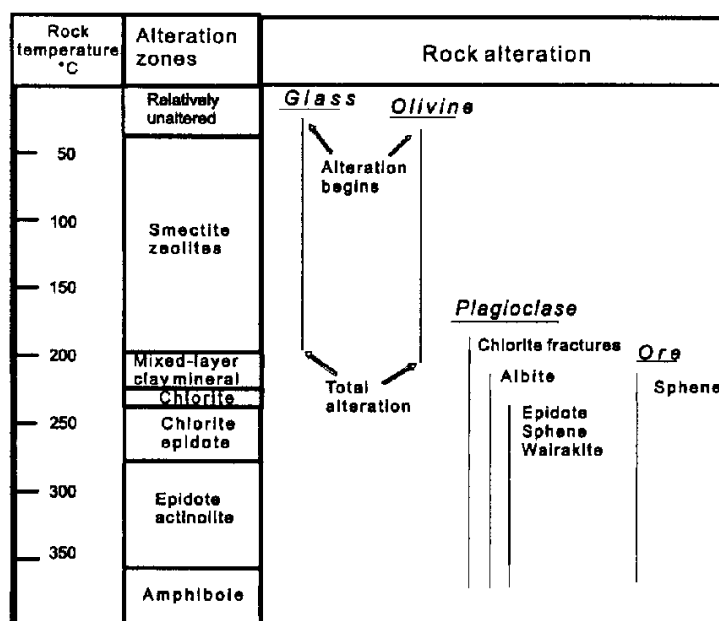

FIGURE 9: Temperature-related alteration zones and rock alteration (Franzson, 1998)

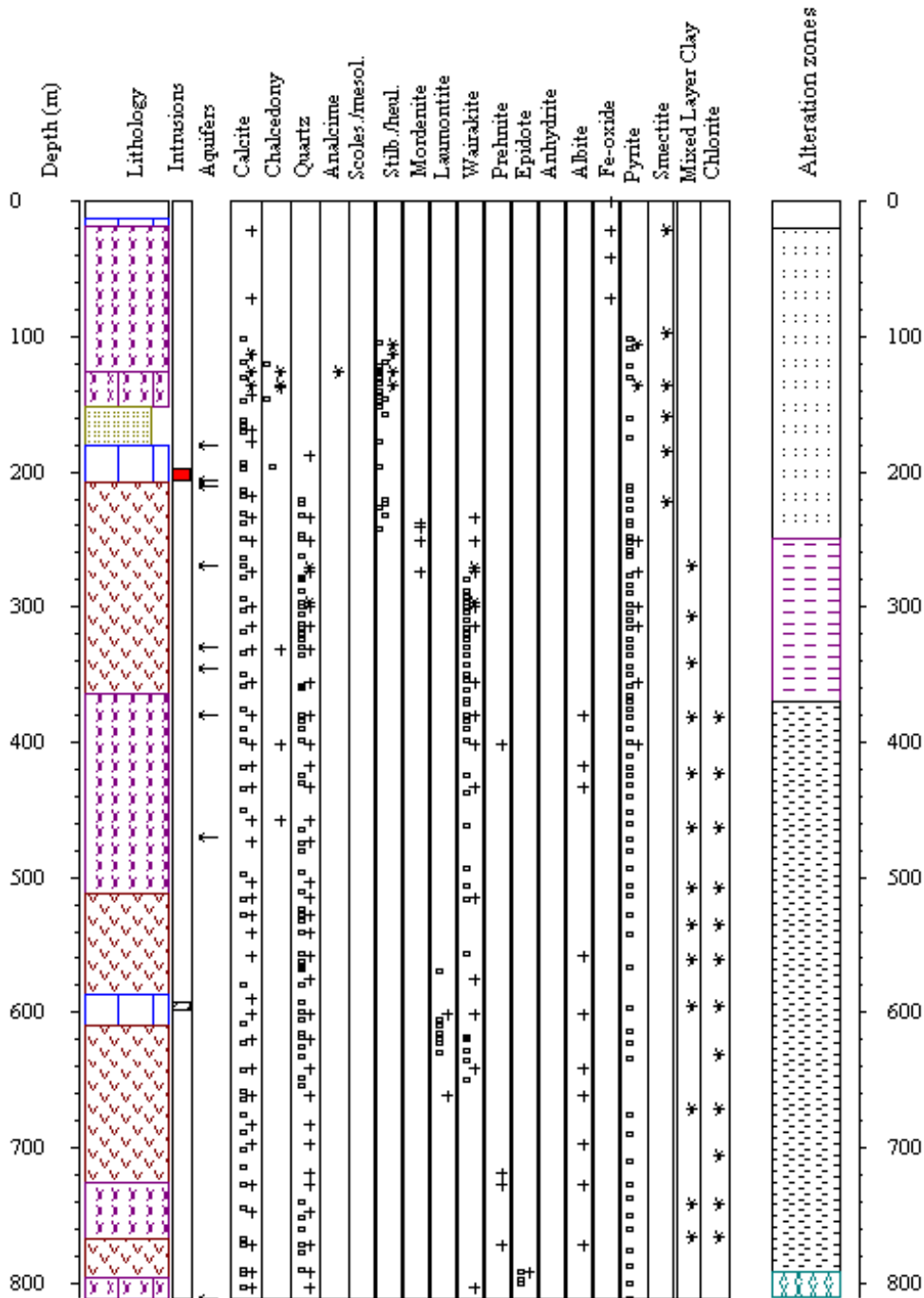

FIGURE 10: Secondary mineral deposition and alteration zones in the upper 812 m of well HE-3 (□ from binocular; + thin section; \* XRD)

**Analcime** has a distinctive trapezohedron crystal form like wairakite. It can be identified by rock type, for analcime is more common in basalt (Tschernich, 1992). XRD analysis showed the presence of analcime at 134 m depth.

**Mesolite/Scolecite** are long, thin, hair-like radial needles usually found with other zeolites like heulandite and stilbite. In this well they are not commonly seen except at a few depths where they are found growing on the top of heulandite and stilbite as was observed at 146 m depth.

**Stilbite** is Ca-Na variety, usually found in characteristic “sheaf-like” aggregates in veins and cavities. It is very common from about 114 m down to 242 m depth below which it seems to be replaced by wairakite and quartz.

**Heulandite** is a Ca-rich variety found in tabular crystal structure with one perfect cleavage and shows parallel extinction in thin-section. It resembles stilbite in many ways but is identified by its better cleavage and other detailed optical properties. It was seen in the XRD-analysis of samples from 114, 122, 134 and 144 m depth.

**Mordenite** is a fibrous, high-silica zeolite commonly found associated with other high-silica zeolites and quartz. It was seen at 230-280 m depth but is pseudomorphed by quartz and calcite, down to deeper levels.

**Laumontite** has a simple elongated prismatic crystal morphology. It turns white and easily crumbles when exposed to dry air due to dehydration. Very well-developed crystals of laumontite were found in cuttings between 570 and 670 m depth. Their occurrences at such deep levels in the well may have implications on the temperature of the system as will be discussed later.

**Wairakite** is a Ca-bearing member of the analcime group, and occurs in a distinctive trapezohedral crystal form. In a thin-section, wairakite shows a characteristic crossed polysynthetic twinning. Fluid inclusions in its crystal structure usually give wairakite a typical cloudy look. Wairakite was commonly found below about 242 m depth, associated with quartz and calcite in veins and vesicles. The appearance of wairakite suggests temperatures of 200°C and it has been shown to exist up to temperatures as high as 300°C (Kristmannsdóttir, 1979).

**Prehnite** was first seen in a thin-section at 410 m but becomes more common below about 700 m depth. It is easily identified in thin-sections by its characteristic bow-tie structure and the resulting wavy extinction, fairly high relief and one good cleavage.

**Epidote** is a yellowish – green crystal in cuttings while in thin-sections it appears colourless to yellowish green and slightly pleochroic in granular to columnar aggregates. It was first identified from cuttings at 792 m depth in the well. It was found to be associated with chlorite, quartz and calcite. Precipitation of epidote in appreciable quantities indicates temperatures of about 250°C (Kristmannsdóttir, 1979).

**Albite** is found as an alteration of plagioclase below about 388 m depth. It is identified in thin-sections by its refractive index, which is equal to or less than balsam and less than the primary labradorite plagioclase, and a very low extinction angle.

**Sphene/Titanite** appeared first at about 410 m depth as a replacement of glass in the groundmass. It looks dark brown and has a very high refractive index and relief. At greater depths sphene replaces ore minerals like magnetite.

**Iron oxides** are found as limonite, which shows reddish tints covering the walls of vesicles. It is found in the upper part of the well. It probably indicates oxidation by groundwater inflow.

**Pyrite** is a widely occurring mineral throughout the entire depth of the well from about 104 m. It occurs both as disseminated grains within the rock matrix and as fracture and vesicular infillings associated with other minerals like zeolites, calcite and quartz. It shows local variation and is most abundant in past and present aquifer zones, especially in the depth interval between 200 and 400 m.

**Clay minerals** are hydrous aluminosilicates with layered structures formed by deposition and/or alteration of glass and other silicate minerals. They are the most voluminous alteration products in geothermal areas and are also the most sensitive within the temperature range of 200-400°C (Kristmannsdóttir, 1979). For this reason they are often used as a geothermometer in geothermal exploration. A total of 21 selected samples from the well were analysed by XRD. They show that three



main types of clays, smectites, mixed-layer clay and chlorites are present in the well. Results of the XRD analysis and the analytical procedures used are given in Appendices I and II.

**Smectites** are considered to be an end member of a compositional series, which expand upon the entrance of water into the interlayered space and facilitates cation exchange (Moore and Reynolds, 1997). Smectite is identified by XRD analysis in samples from the upper 230 m of the well. It shows peaks ranging from 12-15 Å (untreated), 16 Å for glycolated and 10 Å on heating. The XRD results indicate better crystallization of the smectites with increasing depth until it gives way to mixed-layer clay at about 278 m. In thin-sections they look light green to yellowish brown, slightly pleochroic and are found as vesicular linings and alteration of glass.

**Mixed-layer clays** are found as an inter-layering of smectite and chlorite. They show peaks on the average at 32 and 14.7 Å for untreated samples, 15-17 Å when glycolated and 12 Å when heated. They are found from about 278 m down to 390 m depth. In thin section they are highly pleochroic as compared to smectite.

**Chlorite** is identified from about 270 m depth as a mixed layer with smectite all the way down to the bottom where it appears alternatively with a minor amount of mixed-layer smectite - chlorite clay. This may be due to the effect of rock structures where higher-temperature minerals grow in open fractures while lower-temperature assemblages may be present in non-fractured adjacent rocks (Harvey and Browne, 2000). In thin-sections, it is greenish and does not show a marked pleochroism. In XRD it shows peaks of 14 and 7 Å, which do not change upon glycolation and heating.

### 4.3 Alteration mineral zonation

One reason for studying hydrothermal alteration in geothermal exploration is that it gives information about probable formation temperatures. This helps to deduce the temperature of the system in which these minerals are deposited and is especially helpful during drilling when the formation temperature is screened off by the cooling of the circulation fluid. A group of minerals is usually found deposited by the geothermal fluid at more or less the same temperature intervals. This has helped a lot in confining a specific temperature range where an index mineral and associated mineral assemblages are deposited.

Most minerals containing (OH) or  $n\text{x-H}_2\text{O}$  in their crystal structure like clays, zeolites, prehnite and amphiboles are quite often used as geothermometers (Browne, 1984). Experience in Icelandic geothermal areas shows that zeolites are deposited at lower temperatures than 100°C, quartz >180°C, wairakite > 200°C and epidote > 250°C, while temperatures of < 200°C are seen for smectites, 200-230°C for mixed-layer clays and >230°C are assigned to chlorite (Figure 9; Kristmannsdóttir, 1979; Browne, 1984; Franzson, pers. com.).

On the basis of the index mineral and associated mineral assemblages seen in well HE-3, four alteration zones are identified. These zones are identified by the first appearance of the index minerals. They are as follows:

**Smectite - zeolite zone** (< 200°C). This zone is characterised by the presence of smectite together with zeolites like stilbite and heulandite. It covers the depth from about 20 m down to 250 m. The overlying 20 m Postglacial basalt lavas are generally fresh and unaltered.

**Mixed-layer clay zone** (200-230°C). This zone extends from about 250 to 370 m depth and is marked by the presence of a mixed-layer smectite-chlorite clay. Wairakite is also found associated within this zone.

**Chlorite zone** (230-250°C) is defined by the first appearance of chlorite at about 380 m depth, down to the top of the chlorite-epidote zone at about 790 m. Minerals like prehnite, sphene and wairakite are also

found in this zone.

**Chlorite-epidote zone** (>250°C) is marked by the first appearance of epidote at about 792 m. It is characterized by the presence of chlorite and epidote.

#### 4.4 Mineral time sequence

Hydrothermal mineral reactions are inherently self-limiting and reactions are mostly incomplete, so sequences of mineral changes are preserved in the veins and vesicular spaces of the rock matrix. This records successive episodes of water-rock interaction. The studies of these sequential depositions of minerals provide information on the past and present temperature conditions of the geothermal reservoirs. As temperature is the most important factor for the success of a geothermal exploration and exploitation, the knowledge of its change with time in the system forms a vital element in geothermal science.

The study of mineral infilling sequences in veins and vesicular spaces in thin-sections from well HE-3 has shown some time and temperature related depositional sequences of alteration minerals. Results of the microscopic analysis are presented in Table 1 below.

TABLE 1: The sequence of deposition of alteration minerals in the uppermost 812 m of well HE-3

Depth (m)	Older	Younger				
122	Smectite	Heul./stilbite				Calcite
152		Heul./stilbite				Calcite
196	Smectite			C. clay		
226		Heul./stilbite				Calcite
242		Heul./stilbite				Calcite
260	Smectite	Heul./stilbite			Wairakite	
282		Mordenite			Quartz	Wairakite
308		Mordenite			Quartz	Wairakite
340				C. clay	Quartz	
388					Quartz	Wairakite
410		Mordenite			Quartz	Wairakite
466		Mordenite		C. clay		Calcite
536	Smectite	Mordenite			Quartz	Calcite
550		Mordenite			Quartz	
610			P. calcite		Quartz	
628		Mordenite			Quartz	
650			P. calcite		Quartz	Wairakite
692	Smectite			C. clay		
756			P. calcite		Quartz	
780			P. calcite		Quartz	
800			P. calcite		Quartz	
812			P. calcite		Quartz	

C. clay = Coarse clay; P. calcite = platy calcite, Heul. = Heulandite

Table 1 shows that the first minerals to deposit are clay linings (smectite) on cavity walls. These are succeeded, above 600 m, by zeolites (heulandite/stilbite/mordenite), while below 600 m platy calcite forms. The time relation between the zeolites and the platy calcite is still unclear and needs closer attention. Coarse-grained clay (mixed-layer clay/chlorite) appears to deposit on top of the zeolites and then to be succeeded by quartz and wairakite. An interesting relationship is observed where quartz and

wairakite are attacking and partially replacing the older zeolites, suggesting an unstable condition of the later assemblage. The last apparent mineral to deposit is calcite, but is not observed below 540 m depth.

This deposition sequence depicts the development of a geothermal system, initially of relatively low temperature (smectite, zeolites) but being succeeded by higher temperature assemblages (coarse-grained clays, quartz and wairakite), indicating temperature conditions surpassing 200°C. Calcite is a mineral which can either be formed during active boiling or during the inflow of colder fluids into hotter rocks. Calcite is apparently the last mineral to deposit in the upper part of the Nesjavellir reservoir (Franzson, 2000). A fluid inclusion study has confirmed that the calcite was deposited during a cooling episode in the geothermal system. These results may imply that the calcite in well HE-3 might also be a result of apparent cooling. Platy calcite, on the other hand, has often been thought of as being formed during active boiling in a geothermal system.

## 5. AQUIFERS

An aquifer is a permeable formation which can hold fluids and transmit them, so that a well drilled into these formations will be able to tap the fluids. Sources of permeability in rock formations can be faults, intrusions and lithological contacts, joints, clast:matrix or fragment:fragment contacts as has been seen in geothermal wells in the Philippine geothermal systems (Reyes, 1990). A geothermal resource is, in one way or another, a result of water-rock interaction. This includes meteoric water percolating down to the hot rock at depth and rising up as steam, hot water, or a mixture of steam and hot water. Depending on whether they contain this up-flow of geothermal fluid or cold groundwater, aquifers play an important role in either heating up or gradually cooling down the reservoir. It is, therefore, important to have a very good control of all the aquifer zones while drilling a geothermal well. Cold water and other unwanted fluids are kept from getting into the well by casing off and cementing zones containing these fluids.

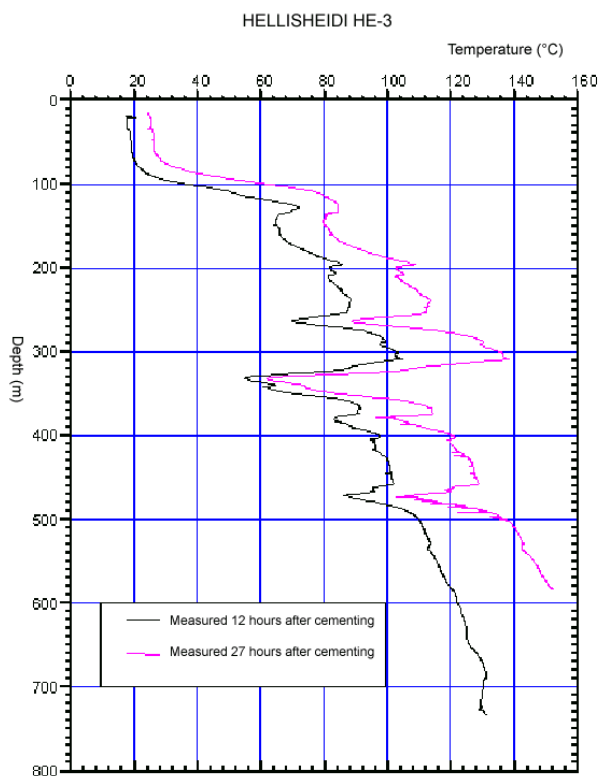

FIGURE 11: Temperature logs from well HE-3 measured 12 and 72 hours after cementing of the production casing

An aquifer (feed point) in a geothermal well is usually identified by closely monitoring circulation losses while drilling. The amount of fluid lost in the formation would also provide information on the size of the aquifer being drilled through. Data from lithological, alteration and geophysical well logs, and especially temperature logs, provide important additional information on the nature and position of aquifers in the well. Circulation loss may range from very minor escape of fluid into a relatively tight formation, to total circulation loss where a highly permeable zone is encountered.

There were no significant circulation losses observed while drilling well HE-3 to 812 m depth. This might be due to the use of bentonite mud as a drilling fluid. This mud has the effect of sealing the pore structures in the wall of the well so that the circulation fluid will not escape into the formations drilled. The aquifers, shown in Figure 8 along with the geological section, are located by making use of data acquired from the lithology, rock and mineral alteration, and geophysical well log analysis, especially temperature logs (Figures 11 and 12). A total of 8 aquifers are identified from the study. All of them are confined to the

150 and 500 m depth interval. They are related to lithological contacts, minor intrusions and textural variation in the hyaloclastite formations. Each of these aquifers is described as follows:

**Aquifer 1** is located at about 180 m depth and relates to a contact between tuffaceous sediments and the underlying basalt layer. Minor circulation losses occurred between 175 and 186 m depth. The caliper log at this depth shows a slight cave, and cooling points from the temperature log suggest an aquifer at this depth. The aquifer is considered to be small.

**Aquifers 2 and 3** are found associated with a narrow basaltic intrusion at 200 to 208 m depth. Minor circulation loss occurred and cooling points in the temperature logs at 195 and 210 m imply aquifers at these depths.

**Aquifers 4, 5, 6 and 7** are all found between 255 and 390 m depth in probably the same basaltic tuff formation. No circulation losses were observed, but minor cooling points at 255, 313, 338 and 390 m are indicated in the temperature logs (Figure 11). The alteration mineral distribution and lithological log also indicate favourable conditions for aquifers at these depths. Higher alteration mineral distribution like pyrite, wairakite, quartz and calcite and high porosity seen in the microscopic study of the thin-sections from this hyaloclastite formation, together with the cooling points seen, imply a feeder zone which later developed into aquifers at these depths.

**Aquifer 8** is at about 470 m and relates to small irregularities within the basaltic breccia formation. The contacts between the different rock fragments, together with veins and vesicles, provide void space for fluid flows. There is a cooling point at 470 m seen in the temperature logs.

All of these aquifers do not yield any fluid into the well for they were all cased off and cemented before the drilling of the production part was carried out below the preliminary bottom at 812 m.

## 6. DISCUSSION

The general stratigraphy of the first 812 m depth of well HE-3 shows hyaloclastites and thin basalt units, which are intruded by two narrow basaltic dykes. On the basis of textural differences, mainly on the differential porphyritic nature of the rocks, the hyaloclastites are divided into five separate formations. They range from near aphyric to highly porphyritic basaltic rocks. The basalt layers are not distinct enough to be considered interglacial units and further data from future wells is needed to verify that. Except for the first 20 m basalt layer, which belongs to the Postglacial lavas of 5000 and 2000 years age,

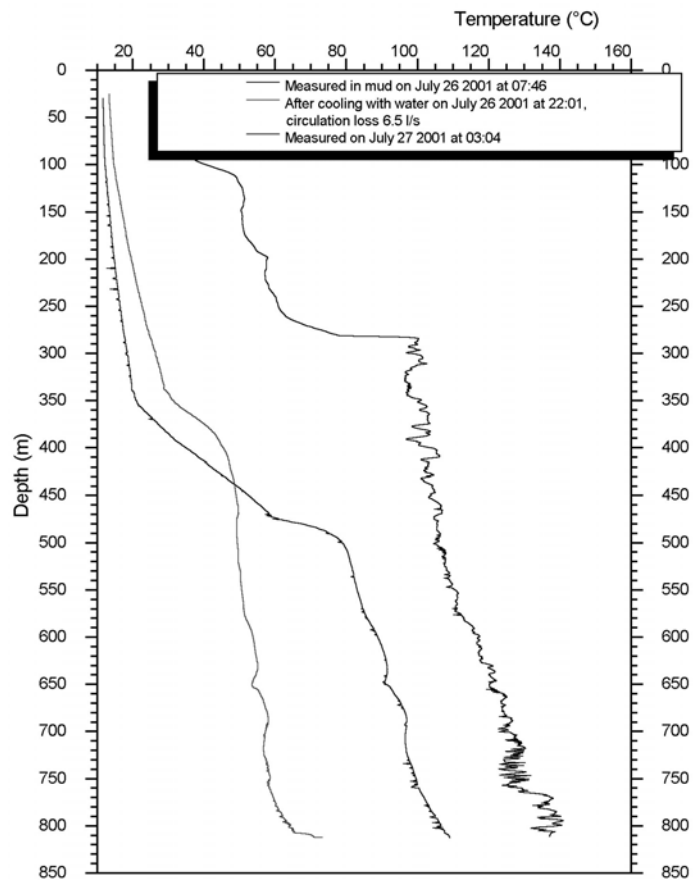

FIGURE 12: Temperature logs from well HE-3 measured before casing and cementing of the production casing

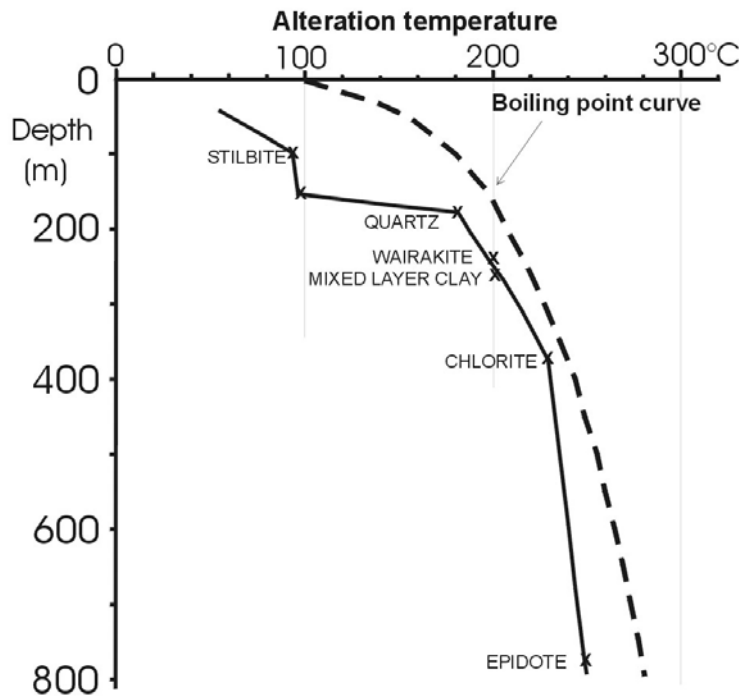

FIGURE 13: Correlation of hydrothermal alteration and boiling temperature curves in the upper 812 m of well HE-3

and the first hyaloclastite formation, possibly the base of Mt. Stóra Skardsmýrarfjall, which is from the last glaciation and thus, younger than 115,000 years, it is not easy to estimate the age of the other formations below, except that they are possibly > 115,000 years. There is evidence from Nesjavellir at the northern part of Mt. Hengill, where the third last period of glaciation was determined at about 600-800 m depth in the geothermal wells. This suggests an age of 0.3 M.y. and was taken to be the age of Mt. Hengill and the maximum age of geothermal activity in the area (Franzson, 1998).

The geological and hydrothermal alteration study shows that the degree and intensity of rock alteration and alteration mineral distribution increases with depth (Figures 8 and 10). This is apparent, especially below about 150 m depth, where a sharp increase in both the number and the amount of alteration

minerals is observed. This may represent a sort of “geothermal unconformity” at that depth, where a relatively unaltered basaltic unit lies on a highly altered tuffaceous formation. It implies that the most intensive high-temperature activity occurred prior to the eruption of the Stóra Skardsmýrarfjall hyaloclastite, an eruption occurring during the last glacial period (12,000-115,000 yrs. ago).

The alteration temperature curve (Figure 13) shows a progressive temperature increase with depth. The correlation of this curve with temperature distribution curves corresponding to free convection in a Hele - Shaw cell (Figure 14) implies that the well is possibly located near an up-flow zone. The alteration mineral assemblage shows the same trend where low-temperature minerals like zeolites from the upper part of the well are gradually replaced by the moderate-temperature minerals like quartz and mixed-layer clays which in turn give way to a higher-temperature mineral assemblage like chlorite, prehnite, sphene and epidote in the lower part of the stratigraphic formation. The clay minerals, which are known for

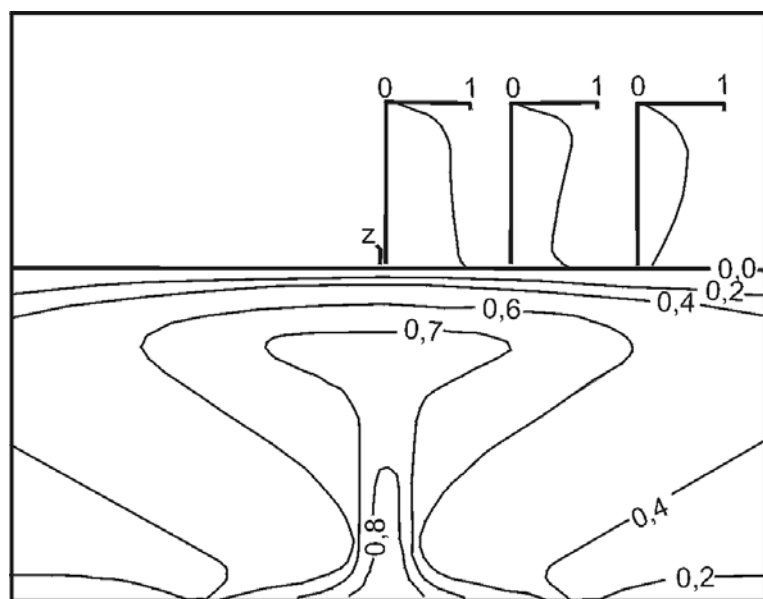

FIGURE 14: Temperature distribution corresponding to free convection in a Hele-Shaw cell (modified from Elder 1965)



their sensitivity to changes in temperature, also become more crystalline with depth. In thin-sections they show a change from fine-grained thin vesicular lining in the upper parts to medium-grained veins and vesicular infillings, and then to more coarse-grained down to the bottom of the well. In the XRD analysis results, they show changes from less imperfect crystals to more perfect crystallization with depth (see Appendices II and III) that implies temperature increases with depth. The four alteration zones also indicate a progressively increasing temperature.

The time-related depositional sequence of the alteration minerals (Section 4.4) implies a geothermal system evolving from low temperature, indicated by the low-temperature zeolite formation at the earlier stage in the sequence, to high temperature that is shown by the presence of high-temperature minerals like quartz, wairakite and calcite. However, data from the Nesjavellir geothermal field indicate that the last deposition of calcite was associated with cooling in the later stages of the geothermal system (Franzson, 2000). The occurrence of laumontite between 570 and 670 m depth is difficult to interpret, as its relationship with other alteration minerals at these depths was not found.

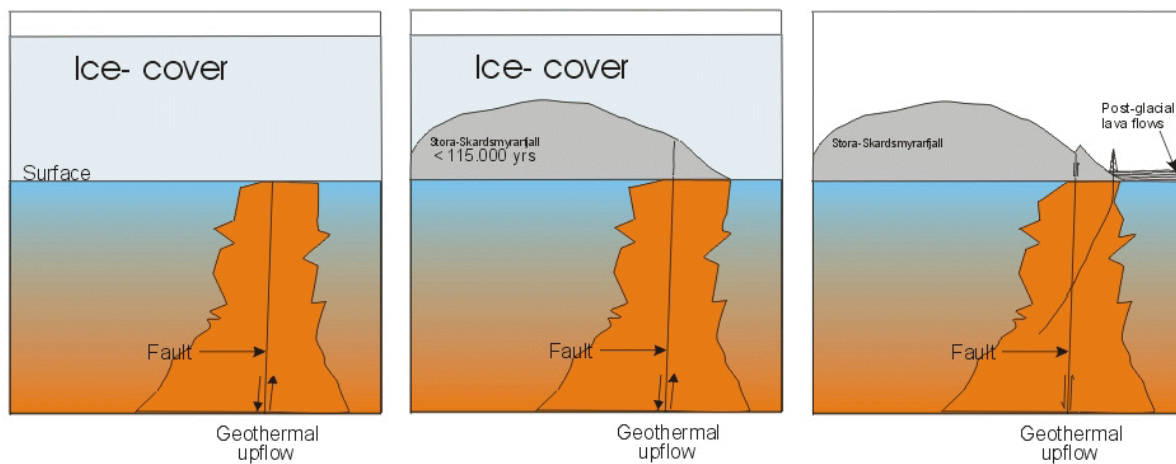

FIGURE 15: A conceptual geothermal model of the uppermost 812 m of the geothermal system into which well HE-3 was drilled

On the basis of the geological findings and the hydrothermal alteration study discussed in the previous sections, and field relationships between the different units and structures, a possible conceptual geothermal model of the system into which the well was drilled is proposed (Figure 15). The main features in the model show that prior to the eruption of the Stóra Skardsmýrarfjall hyaloclastite unit, a very active geothermal system was possibly associated with this fault extending to the surface, which at that time was at about 150 m depth below the present surface. This is marked by the deposition of water-lain tuffaceous sediments as a result of the last glacial age onto the previous glaciation. This was followed by the eruption of the Stóra Skardsmýrarfjall hyaloclastite during the last glacial period. It is thus postulated that the fault may have had a long active history extending possibly from before the last glaciation to the present day. Continuous movement along the fault plain may have led to repeated revitalization of permeability throughout its life. A throw of about 80 m was observed on Stóra Skardsmýrarfjall hyaloclastite (Steingrímsson et al., 2001). The last glacial activity, the Postglacial lava flows and this active fault have shaped the present topography of the area. It is the author's belief that as more data become available in the future, a better picture of the geothermal system in the area can be drawn.

Aquifers are confined within the uppermost 180-500 m depth and are related to lithologic boundaries, intrusion contacts, and rock structures like veins, vesicles and other void spaces in the rock matrix. They were excluded by casing and cementing of the well down to the shoe of the production casing.

## 7. CONCLUSIONS

The following conclusions are made from this study:

- The general stratigraphy of the first 812 m of well HE-3 consists of hyaloclastites, which make up more than 90% of all the units. The rest consists of thin basalt layers and two minor basaltic intrusions.
- The alteration mineral assemblage and distribution study indicates the presence of four temperature related alteration zones. These are smectite-zeolite zone (<200°C), mixed-layer clay zone (200-230°C), chlorite zone (230-250°C), and chlorite-epidote zone (>250°C).
- The time-related mineral depositional sequence shows a geothermal system evolving from low temperature through moderate to high temperature. The last mineral to deposit, calcite, may imply some later cooling, but that needs further verification, by e.g. fluid inclusion study.
- The alteration mineral temperature curve, as compared to the temperature distribution curves in a free convective cell, suggests that the well is possibly located near an up-flow zone.
- From the geological and alteration studies and field relationships, it is suggested that the most active geothermal stage in the system occurred prior to the eruption of the Stóra Skardsmýrarfjall hyaloclastite.
- Aquifers are generally small and confined within the upper half section of the well and are related to lithological boundaries, intrusion contact and rock structures.

## ACKNOWLEDGEMENTS

I am greatly indebted to my advisors Dr. Hjalti Franzson and Mr. Ásgrímur Gudmundsson, for their valuable discussions and unreserved dedication in assisting me in whatever way I needed during this project. My special thanks go to Dr. Ingvar B. Fridleifsson and Mr. Lúdvík S. Georgsson, Director and Deputy Director of the Geothermal Training Programme, and Mrs. Guðrún Bjarnadóttir, for their kindness and assistance during the whole course of the training programme. Thanks are due Mr. Sigurdur S. Jónsson for his generous support in the XRD analysis and to all the staff of the Orkustofnun - Geoscience Division who, in one way or another, were very helpful. I would like to express my gratitude to the United Nations University and the Icelandic government for the UNU Fellowship I was awarded, and the Ethiopian Geological Survey for letting me participate in this significant training programme.

Finally, my deepest thanks to all my family and friends, especially my beloved brother, Menelik Getaneh, who have been my sources of comfort. May God keep them all.

## REFERENCES

Árnason, K., Karlsdóttir, R., Eysteinnsson, H., Flóvenz, Ó.G., and Gudlaugsson, S.Th., 2000: The resistivity structure of high-temperature geothermal systems in Iceland. *Proceedings of the World Geothermal Congress 2000, Kyushu-Tohoku, Japan*, 923-928.

Björnsson, A., Hersir, G.P., and Björnsson, G., 1986: The Hengill high-temperature area, SW-Iceland: Regional geophysical survey. *Geoth. Res. Council, Transactions, 10*, 205-210.

- Browne, P.R.L., 1978: Hydrothermal alteration in active geothermal fields. *Annual Reviews of Earth and Planetary Science*, 6, 229-250.
- Browne, P.R.L., 1984: *Lectures on geothermal geology and petrology*. UNU G.T.P., Iceland, report 2, 92 pp.
- Elder, J.W., 1965: Physical processes in geothermal areas. In: Lee, W.H.K.(ed.), *Terrestrial heat flow*. American Geological Union, Publ. No. 1288, 211 – 239.
- Elders, W.A., 1977: Petrology as a practical tool in geothermal studies. *Geoth. Res, Council, Transactions*, 1, 85-87.
- Foulger, G.R., 1988: Hengill triple junction, SW-Iceland, 1. Tectonic structure and the spatial and temporal distribution of local earthquakes. *J. Geophys. Res.*, 93-B11, 13493 – 13506.
- Franzson, H., 1998: Reservoir geology of the Nesjavellir high-temperature field in SW-Iceland. *Proceedings of the 19<sup>th</sup> Annual PNOC-EDC Geothermal Conference, Manila*, 13-20.
- Franzson, H., 2000: Hydrothermal evolution of the Nesjavellir high-temperature system, Iceland. *Proceedings of the World Geothermal Congress 2000, Kyushu-Tohoku, Japan*, 2075-2080.
- Harvey, C., and Browne, P., 2000: Mixed-layer clays in geothermal systems and their effectiveness as mineral geothermometers. *Proceedings of the World Geothermal Congress 2000, Kyushu-Tohoku, Japan*, 1201-1205.
- Kerr, P.F., 1959: *Optical mineralogy* (3<sup>rd</sup> edition). McGraw-Hill Book Company, New York, 442 pp.
- Kristmannsdóttir, H., 1975: Hydrothermal alteration of basaltic rocks in Icelandic geothermal areas. *Proceedings of the 2<sup>nd</sup> U.N. Symposium on the Development and Use of Geothermal Resources, San Francisco*, 441-445.
- Kristmannsdóttir, H., 1979: Alteration of basaltic rocks by hydrothermal activity at 100-300°C. In: Mortland, M.M., and Farmer, V.C. (editors), *International Clay Conference 1978*. Elsevier Scientific Publishing Co., Amsterdam, 359-367.
- Moore, D.M., and Reynolds, R.C., 1997: *X-Ray diffraction and the identification and analysis of clay minerals* (2<sup>nd</sup> edition). Oxford University Press, New York, 378 pp.
- Reyes, A.G., 1990: Petrology of Philippine geothermal systems and the application of alteration mineralogy to their assessment. *J. Volc. Geoth. Res.*, 43, 279-309.
- Steingrímsson, B., Franzson, H., Magnússon, I.Th., Árnason, K., Saemundsson, K., Thordarson, S., Thórhallsson, S., 2001: *Wells HE-3 and HE-4 at Hellisheidi. Siting and design of the wells*. Orkustofnun, Reykjavík, report OS-ROS-01/01 (in Icelandic), 17 pp.
- Saemundsson, K., 1979: Outline of the geology of Iceland. *Jökull*, 29, 7-28.
- Saemundsson, K., 1995a: *Geological map of the Hengill area 1:50,000*. Orkustofnun, Reykjavík.
- Saemundsson, K., 1995b: *Geothermal and hydrothermal map of the Hengill area, 1:25,000*. Orkustofnun, Reykjavík.
- Tschernich, R.W., 1992: *Zeolites of the world*. Geoscience Press, Inc., Arizona, 563 pp.

**APPENDIX I: Sample preparation of minerals for XRD analysis and XRD results**

The following is the step-by-step procedures followed in the sample preparation for hydrothermal minerals and clay mineral analysis by the XRD technique.

**I. For zeolites and other hydrothermal mineral analysis:**

1. Pick the mineral grains for study under the binocular microscope. Avoid as much as possible any feldspars from getting into your sample, otherwise they cause difficulty in later interpretation of results as they have many refractions that interfere with almost anything you want to analyse.
2. Crush the sample in an agate bowl to attain a powder of 5-10 microns grain size. Keep the sample wet by adding acetone to prevent loss of sample while powdering.
3. Fill the sample window slot with an appropriate amount of powdered sample, then press a glass slide against the sample in a slot to make it firm, flat and level.
4. Run the sample from 4-60° on the XRD.

**II. For clay mineral analysis:**

1. Place approximately two teaspoons of drill cuttings into a test tube. Wash out dust with distilled water. Fill the tubes 2/3 with distilled water and plug with rubber stoppers. Place the tube in a mechanical shaker for 4-8 hours, depending on the alteration grade of the samples.
2. Remove the test tubes from the shaker and allow to settle for 1-2 hours, until particles finer than approximately 4 microns are left in suspension. Pipette a few ml from each tube, half way before the level of the sample, and place about ten drops on the labelled glass slide. Avoid having the samples thick. Make a duplicate for each sample and let it dry at room temperature overnight.
3. Place one set of the samples in a desiccator containing Glycol ( $C_2H_6O_2$ ) solution and the other set in a desiccator containing  $CaCl_2 \cdot 2H_2O$ . Store at room temperature for at least 24 hours. Thick samples will need a longer time in the desiccator or at least 48 hours.
4. Run both sets of samples from 2 to 15° on the XRD.
5. Place one set of the samples (normally the glycolated one) on an asbestos plate and heat in a pre-heated oven at 500-550°C. Oven temperature must not exceed 550°C. The exact location of individual samples on the asbestos plate must be known before heating because labelling will disappear during the heating process. Cool the samples sufficiently before further treatment.
6. Run the samples from 2-15° on the XRD.

**APPENDIX II: Results of the XRD analysis of clay minerals**

Depth (m)	Untreated (Å)	Glycolated (Å)	Heated (Å)	Results
30	14.99	16.34	10.08	Smectite
106	14.87, 13.21	16.83	9.92	Smectite
144	14.91, 12.64	16.87, 13.42	9.84	Smectite
168	15.15	16.55	9.84	Smectite
194	15.18	16.62	9.76	Smectite
230	14.9, 12.77	16.7	9.82	Smectite
278	32.71, 14.48	32.71, 15.12	12.96, 9.1	MLC
316	-	32.26, 14.39	13.1	MLC
350	32, 14.48, 7.14	32, 14.48, 7.14	14.5, 10.17	MLC
390	32, 14.48, 7.14	32, 14.48, 7.14	14.08	MLC, chlorite
432	32, 14.56, 7.18	32, 14.56, 7.18	14.29, 10.17	MLC, chlorite
472	30.75, 14.45, 7.15	30.75, 14.45, 7.15	14, 10.17	MLC, chlorite
516	30.23, 14.45, 12.8, 7.23	30.23, 14.45, 15.2, 16.2, 7.23	13.84, 12, 9.8	MLC, chlorite
544	30.23, 14.17, 12.8, 9, 7.16	30.23, 14.17, 9, 7.16	13.84, 12.38, 9.85, 8.05	MLC, chlorite
570	30.23, 14.54, 9.16, 7.16	30.23, 14.54, 9.16, 7.16	13.37, 12.38, 8.05	MLC, chlorite
604	30.23, 14.54, 7.16	30.23, 14.54, 9.16, 7.16	13.37, 12.38, 8.05	MLC, chlorite
640	14.45, 7.15	14.45, 7.15	14.15, 10.15, 7.15	Chlorite
680	30.23, 14.39, 9.25, 7.19	30.23, 14.39, 9.25, 7.19	12.87, 8.04, 7.2	Chlorite, MLC
714	14.45, 7.18	14.45, 7.18	14.45, 7.18	Chlorite
750	30, 14.57, 7.18	30, 14.57, 7.18	14.57, 12.88, 8.03, 7.18	Chlorite, MLC
774	30, 14.54, 7.18	30, 14.54, 7.18	14.39, 12.87, 8.03, 7.18	Chlorite, MLC

**APPENDIX III: Characteristic XRD patterns for the clay minerals found in the upper 812 m of well HE-3**

